

mlD heated mirrors (with light & demister)

Product code: MLD 900
900(w) x 600(h) x 45(d) mm

Features

Built-in LED light • Built in Demister • Available in 3 sizes • Electronic touch pad for on /off control • Hardwired only

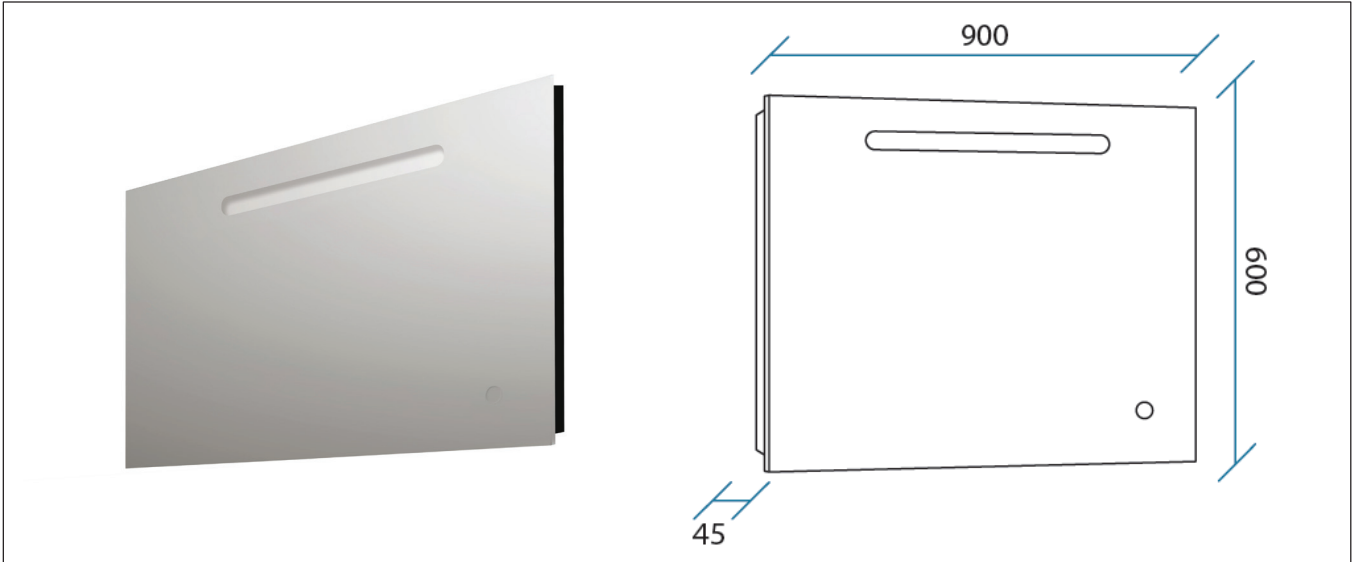

- A: Distance from the edge of the backplate to the centre of the bracket - **80mm**
 C: Distance from the edge of the backplate to the centre of the bracket - **80mm**
 B: Distance between the 2 brackets - **660mm**
 D: Distance from the top of the backplate to the centre of the bracket - **80mm**
 E: Distance from the centre of the bracket to the bottom edge of the backplate - **440mm**
 F: The space between the backplate and the mirror - **40mm**
 Power Cord exit - **370mm** from top of mirror.

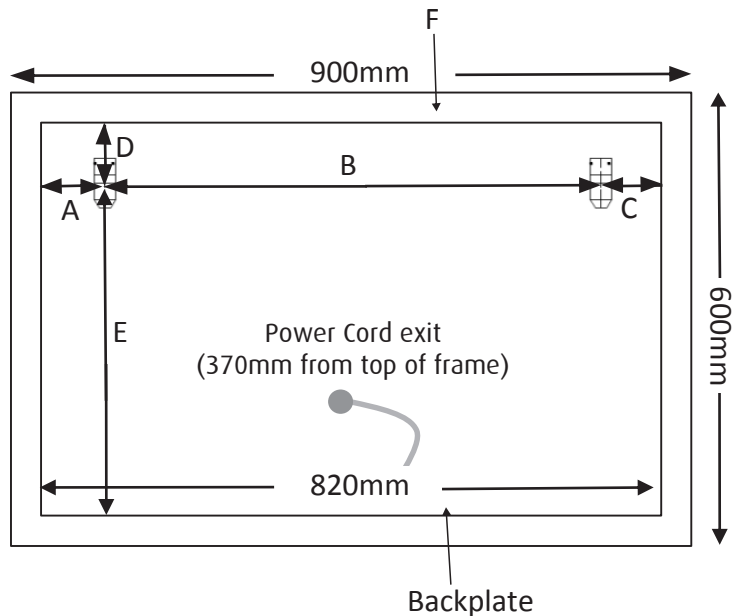

Additional information

- 2 year warranty
- 42 watts at 220-240 Volts AC 50 Hz