

Premium 14 bar SQUARE

Product code: HTR-TS1451

510(w) x 850 (h) x 120 (d) mm

Features:

- 14 bars • Hand polished mirror finish • High grade stainless steel • Universal cable
- Concealed wiring kit included • Easily installed into new and existing homes.

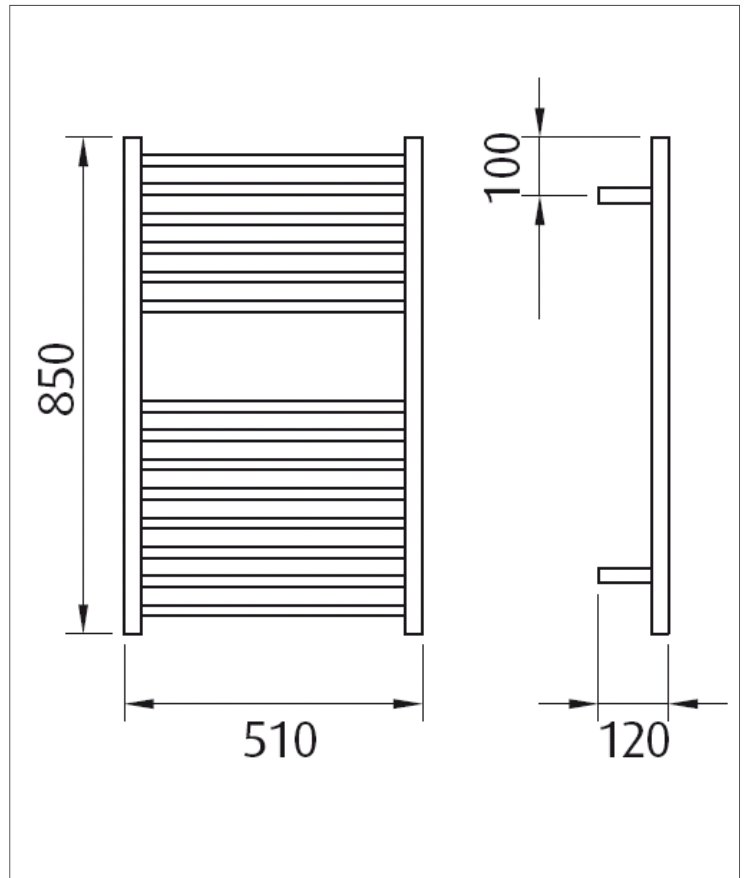

Width centre: 480mm Vertical centre: 650mm

Note: Manufacturing tolerances could cause variances of ±5mm.



Additional Information

- 110watts
- 230-240Volts, 50Hz single phase
- Class 1 appliance – requires an earth connection
- This rail should be mounted vertically with the cord exiting from the base.
- It should be positioned at least 600mm above the floor.
- Ingress Protection Rating: IP45– Splashproof